

MOBA MATIC & BIG SONIC SKI



20

20

MOBA MATIC & BIG SONIC SKI / LEVELLING SYSTEMS
MOBA-AUTOMATION.COM

MOBA MATIC - THE WORLD'S MOST FLEXIBLE LEVELLING SYSTEM FOR ROAD CONSTRUCTION

The world-renowned **MOBA-matic** is the best-selling levelling system in road construction. Its simple operation, exceptional robustness and absolute precision have ensured its strong market positioning. The technology, which was introduced in 1991, is now the leading levelling system in road construction and is installed as standard on asphalt pavers of all major machine manufacturers.

After a single set-up, the system immediately controls the screed thickness – fully automated. Combined with the appropriate CAN-based sensors, even the most complex construction project can be accomplished. In more than 45 years on the market, the MOBA control unit and sensors have been perfectly matched to each other to form a single unit. The right solution has been developed specifically for every application in asphalt paving. Benefit now from the world's largest selection of sensors!

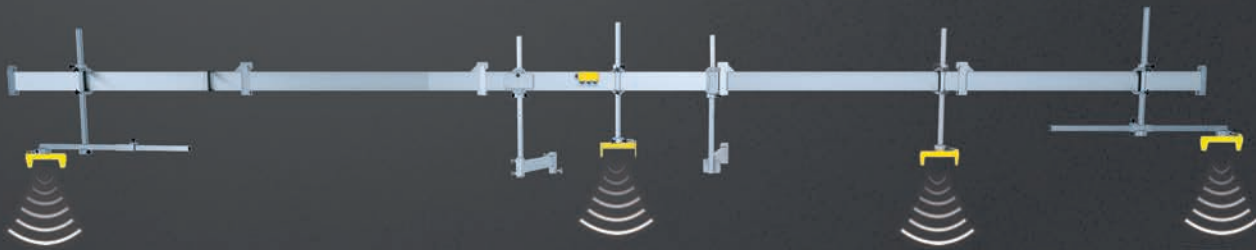

As a combination, **MOBA-matic** and the sensor solution **Big Sonic-Ski** with up to 4 ultrasonic sensors are absolutely unbeatable! Thanks to a span of up to 13 m, even long ground waves are completely levelled out and eliminated. This unique feature ensures an exceptionally flat surface and makes the system not only the most precise technology on the market, but also an absolutely groundbreaking solution. Welcome to road construction of the future!



45 YEARS OF PIONEERING SPIRIT

We live progress! More than **45 years of experience** in road construction and pioneering spirit since the first day distinguish MOBA Mobile Automation AG as an innovator in the automation industry. **MOBA-matic** and **Big Sonic-Ski** are firmly established in the market as leading systems and are indispensable today.

Did you know?

Our proven technologies for road construction are always supplemented by newly developed innovation systems to ensure long-term quality in road construction. With systems such as **PAVE-IR** for automatic temperature measurement and **PAVE-TM** for non-contact coating thickness measurement, your machines will be perfectly equipped for the construction site of the future.



MOBA-MATIC II

VERSATILITY ERGONOMICALLY PACKED

SYSTEM ADVANTAGES

- » Increased efficiency through fully automatic control of the screed thickness
- » High-precision levelling results
- » Universal operation possible on all types of pavers
- » Flexible applications thanks to largest CAN-based sensor selection
- » Ergonomic, intuitive 4-button design
- » Time-saving through 3D capability
- » Cost-effective upgrades possible thanks to exceptional modularity



MOBA-MATIC II CONTROLLER

THE „HEART” OF THE SYSTEM

The controller of the **MOBA-matic** is characterised by its exceptionally ergonomic handling. The practical 4-button design for quick and easy operation has been integrated into every further development and has been further optimised. Specially developed features such as the easy-to-read design for night operation and the practical illuminated display as a height indicator complement the intuitive operation of the panel. The particularly robust technology convinces first and foremost in terms of durability. Some of them have already been in use **for more than 20 years**.

MOBA-MATIC II DISPLAY

EVERYTHING AT A GLANCE

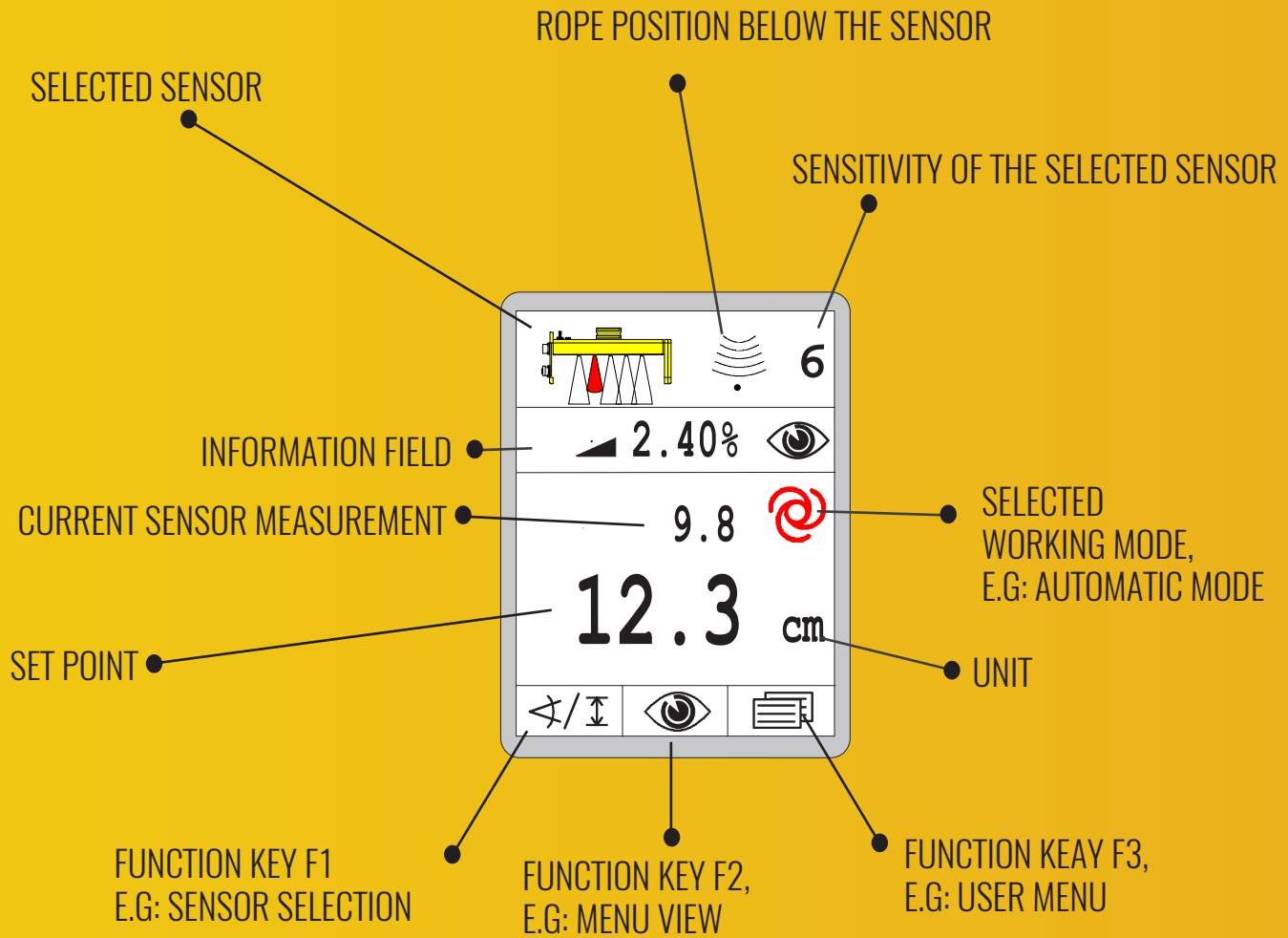



BIG SONIC-SKI

NOBODY IS THIS **SMOOTH**

SONIC-SKI PLUS

- » Wear-free sensor
- » Non-contact rope and ground sensing
- » Determination of measured values taking into consideration interference factors

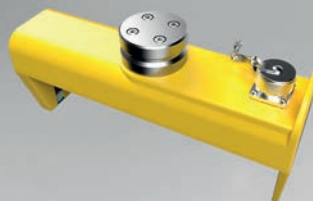

01

DIGI SLOPE

- » Specially designed for high compaction screeds
- » Inclination display for height control



02

LASER RECEIVER LS-3000

- » Compatible with all common rotary lasers for machine control
- » Linear detection of the laser beam
- » No electric mast required for height adjustment
- » Operating point selection at the touch of a button



03

ROTARY ENCODER

- » Can be used in all weather conditions
- » Suitable for rope and ground sensing



04

WIRE-ACTUATED SENSOR

- » Precise height position measurement for cutting applications
- » Rope (wear part) can be replaced by the user
- » Measuring range: 500 mm



05

IR TEMPERATURESENSOR

- » Measurement of material temperature
- » Installation in the material hopper or in front of the paver
- » Real-time temperature display on the MOBA-matic II



06

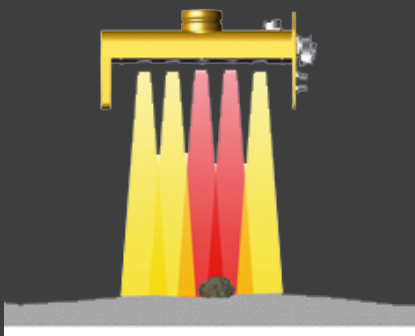

Sensor 1 + Sensor 2 + Sensor 3 + Sensor 4 + Sensor 5

3

The **Sonic-Ski PLUS** has been in constant development for 20 years and has firmly established itself as a flexible sensor technology in road construction. Thus, the sensor can be changed from ground to rope sensing in just one action and is therefore a real time miracle with changing references. As an ultrasonic sensor that scans the height reference without contact, it is completely wear-free and therefore far superior to other technologies in terms of durability. Disturbing influences such as rain, stones or edges are immediately detected and faded out to guarantee the installation of an absolutely even surface.

- » Wear-free sensor thanks to non-contact sensing
- » Absolute robustness of measured value owing to suppression of interference factors
- » Absolute robustness of measured value owing to suppression of interference factors
- » Flexible, time-efficient adaptation to different references



DIGI SLOPE FAVOURING SLOPES

The digital inclination sensor can be optimally integrated into the CAN network of the system and thus complements the levelling system with a powerful inclination control for paving slopes. The state-of-the-art technology systematically suppresses shocks and accelerations and thus makes your levelling work many times more precise. Thanks to the minimal cable installation, the number of wear parts and the associated potential sources of error are reduced to a minimum.

ADVANTAGES:

- » Faster operation thanks to automated tilt control
- » New generation digital sensor that works even faster and more precisely
- » Cable savings thanks to integration into the CAN bus

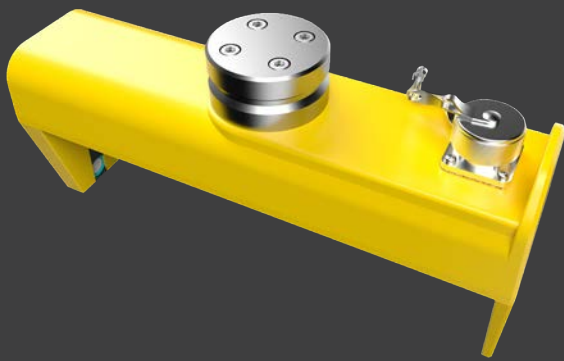

SONIC SKI PLUS FLATNESS PERFECTED



BIG SONIC-SKI - QUICKLY ASSEMBLED – THE BEST RESULTS

With up to four variably positionable sensors, the Big Sonic-Ski is a sensor solution in a class of its own. The combination of four sensors is the only technology on the market that detects long-wave unevenness and thus achieves the most precise flatness.

Thanks to quick mounting on the robust aluminium frame, the sensors can be placed individually for each application to measure the height at the right place. Thus, the Big Sonic-Ski is the right solution for every project – whether road, car park, racetrack, airport or roundabout, whether straight road or winding track. Adjustments in the installation are implemented on site in the shortest possible time.

Thanks to non-contact ground sensing of the acoustic ultrasonic sensors, this technology is considered wear-free. The system's longevity is particularly impressive in harsh environments. Its resistance to heat, vibration, dust and water is an absolute must on the construction site.

SYSTEM ADVANTAGES

- » High precision through constant averaging of measurements from four independent sensors
- » Time-saving owing to user-friendly assembly and flexible handling
- » Increased uniformity by sensing large surfaces



BIG SONIC-SKI - AVERAGING OVER LONG DISTANCES

- » Combination of 4 Sonic-Ski Plus sensors
- » Sensing of several, widely spaced points
- » Averaging and derivation of a virtual reference level
- » Even elongated irregularities are levelled out

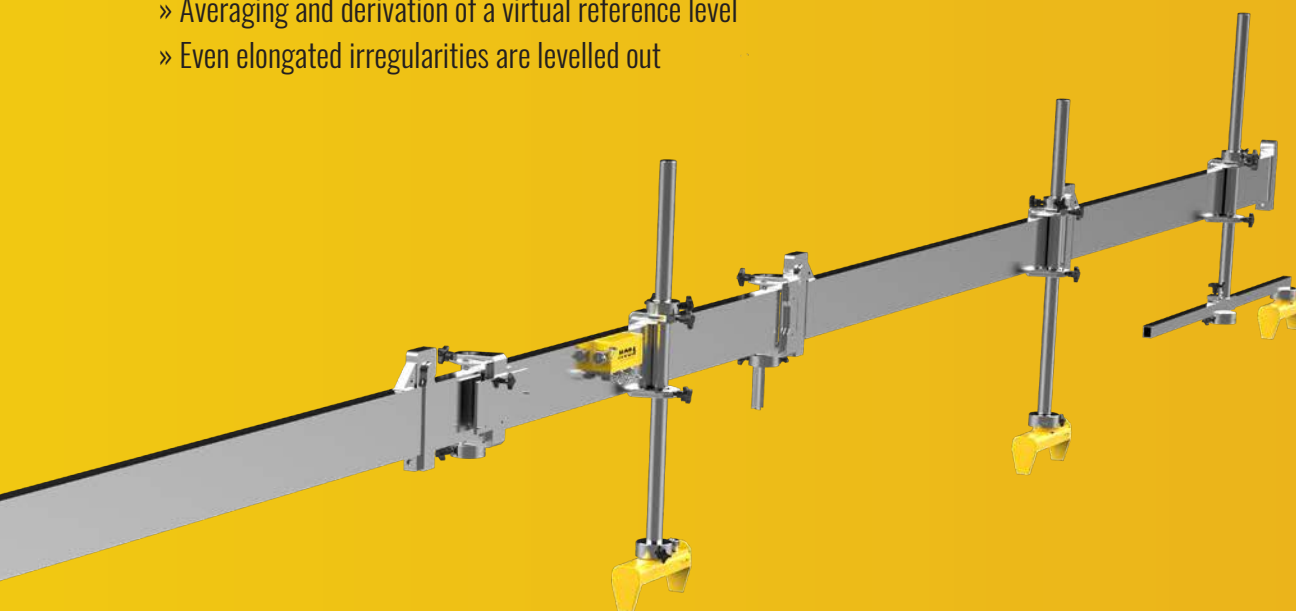

SKI1+SKI2+SKI3+SKI4

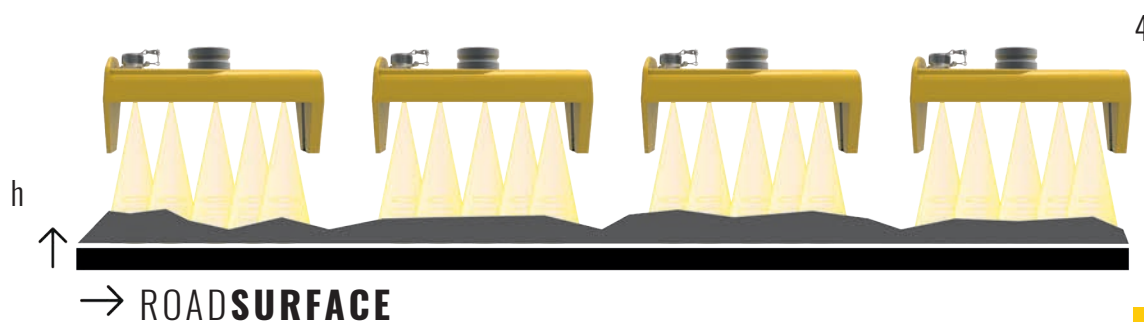

FIRST CHOICE IN ROAD CONSTRUCTION

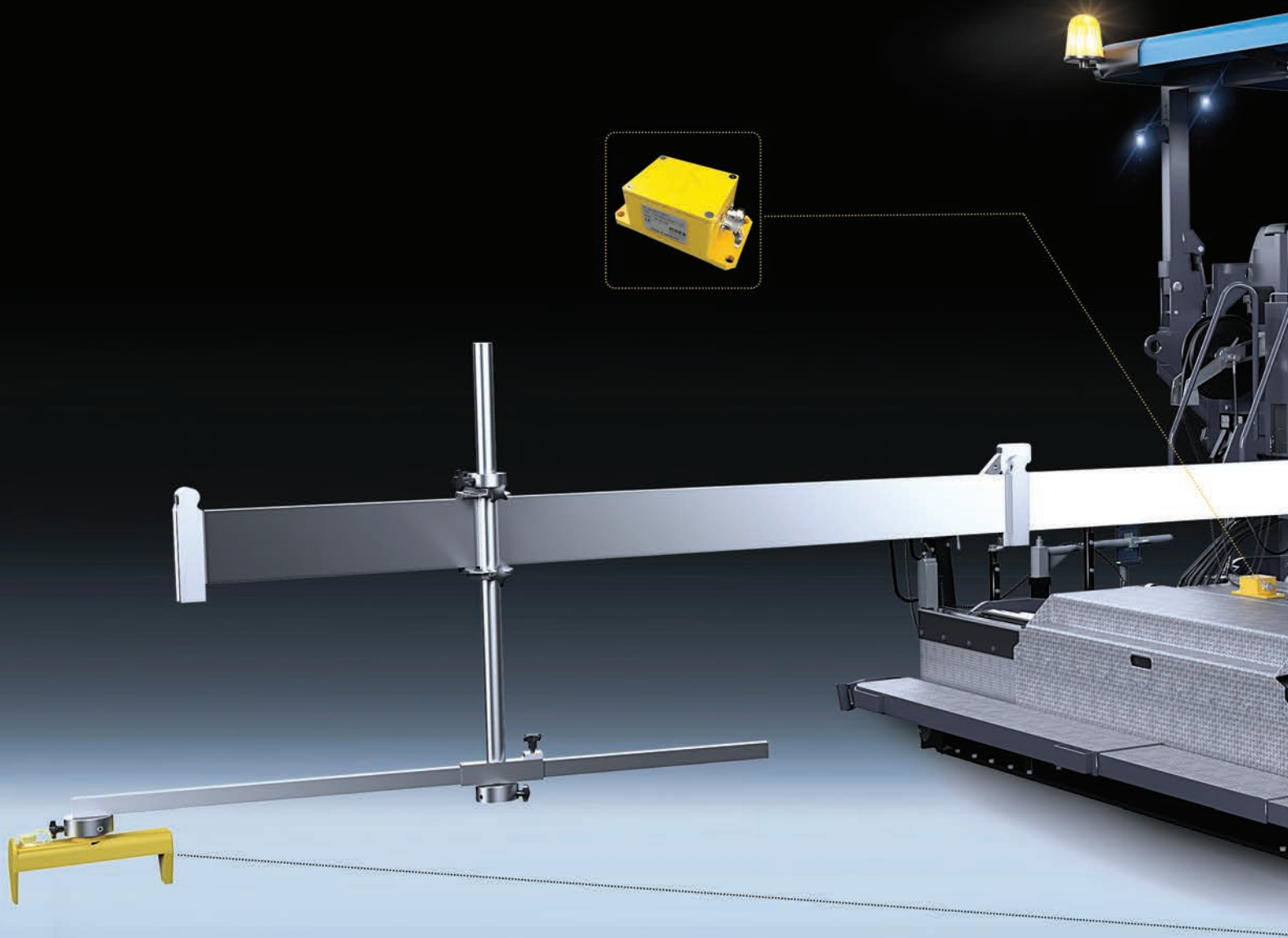

ABSOLUTE FLATNESS WITH EVERY PAVER

Thanks to years of development and market experience, MOBA-matic and Big Sonic-Ski are compatible with the pavers of any machine manufacturer – regardless of type or age. Thanks to the CAN-based development of further hardware components with a focus on the modularity of the system, additional features can easily be added. IR spot temperature sensors, laser receivers or prisms offer even more installation options.

1. **MOBA-matic II Controller** easy-to-use panel
2. **Big Sonic-Ski** unique sensor solution for height measurement
3. **Digital tilt sensor** for tilt indication during altitude control
4. **Laser Receiver LS-3000** linear detection of the laser beam
5. **Seilzugsensor** precise height position measurement for cutting applications
6. **IR-Spot temperature sensor** can be used at freely selectable positions of the paver

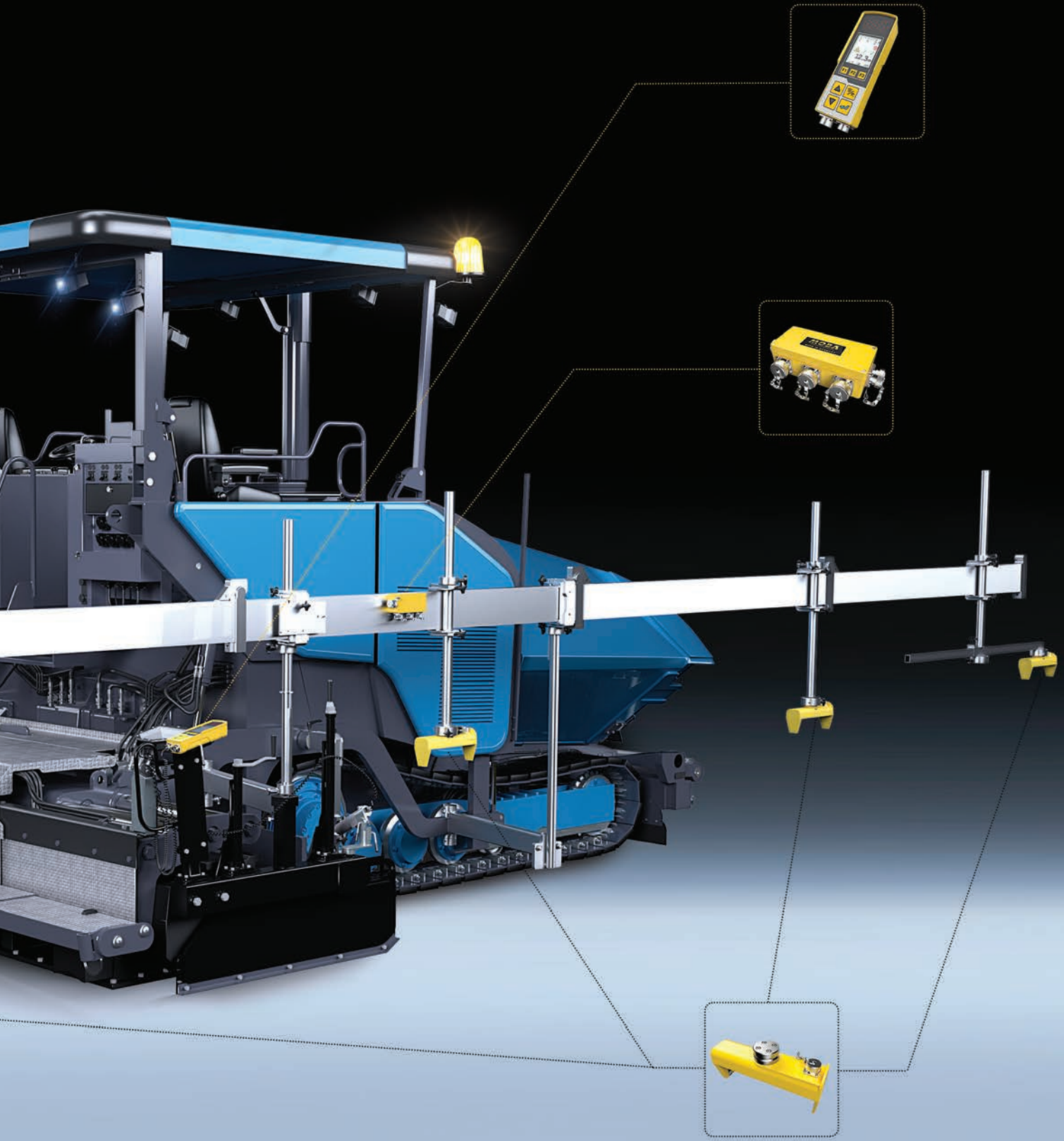

1



2



3



4

























5



6

MOBA-matic - OVERVIEW & FEATURES

MOBA-matic - FUNCTIONS AND FEATURES OVERVIEW

					
FEATURES LIST		VÖGELE JUNCTION BOX	MOBA JUNCTION BOX FÜR VÖGELE	MOBA-MATIC I	MOBA-MATIC II
	Simple button operation	☑	☑	☑	☑
	Can be adapted to any hydraulic system	☑	☑	☑	☑
	Individual optimisation options	☑	☑	☑	☑
	Monochrome display	☑	☑	☑	☒
	Brilliantes TFT color display	☒	☒	☒	☑
	Adjustable LED brightness	☒	☒	☒	☑
	Clearly illustrated information / Icon design	☒	☒	☒	☑
	Target / Actual Value Display	☒	☒	☒	☑
	Menu Buttons for additional Functions	☑	☑	☒	☑
	Additional display of a sensor value (e.g. temperature, slope, etc.)	☒	☒	☒	☑
	Multilingual Service Menu	☒	☒	☒	☑
	Can be remotely operated	☒	☒	☒	☑
	Path-dependent cross-slope control	☒	☒	☒	☑
	Ergonomic design	☒	☒	☑	☑
	Vögele Sonic-Ski Sensor (CAN)	☑	☑	☑	☑
	MOBA Sonic-Ski Sensor (CAN)	☒	☑	☑	☑
	MOBA Sonic-Ski PLUS Sensor (CAN / PWM)	☒	☑	☑	☑
	MOBA Sonic-Ski PLUS Sensor (CAN)	☒	☑	☑	☑
	Big Sonic-Ski with 3 Sensors	☑	☑	☑	☑
	Big Sonic-Ski with 4 Sensors	☒	☒	☒	☑

EQUIPPED FOR MIXED FLEET OF ASPHALT PAVING MACHINES

THE EXPERT NETWORK - INSPIRING MOBILE AUTOMATION

Would you like to know how the system has already been successfully deployed by our customers? In the online expert blog, **MOBA Community**, you will find everything from job stories, feature releases, discussion forums to field reports to inform you in detail about our technologies.

Besides blog contributions regarding automation solutions of MOBA Mobile Automation AG, the Community offers numerous forums, discussions, event announcements or expert contributions about various topics of automation of construction machines. The **MOBA Community** acts as an interactive, international exchange platform for everybody who would like to participate actively in the development of this industry.

Contribute your own know-how and perspectives to interesting dialogues, post important questions regarding the (r)evolution of the industry and exchange opinions and experiences with other experts.

JOIN THE EXPERT NETWORK -
WWW.MOBACOMMUNITY.COM

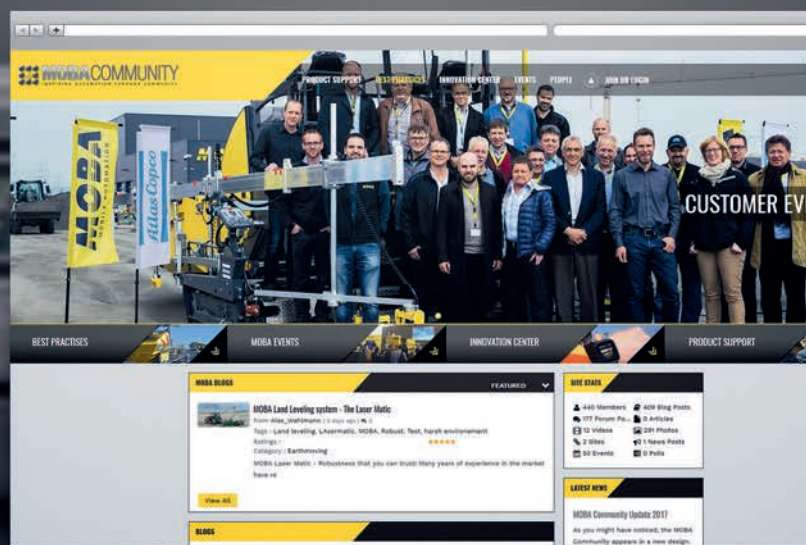

ONE GROUP - ONE RESPONSIBILITY



● HEADQUARTERS ● SUBSIDIARIES ● DEALER

MOBA GROUP

The **MOBA GROUP** is a leading global player in the world of mobile automation. Close collaborations between the headquarter in Limburg an der Lahn and subsidiaries all over Europe, Asia, North and South America create new perspectives for recent and future developments.

Superior technical know-how and more than 40 years of experience combined with an international dealer network guarantee a premium support - **worldwide. INSPIRING MOBILE AUTOMATION** - this is what the **MOBA GROUP** stands for since more than **40 years**.

MOBA GERMANY

65555 Limburg / Germany
Phone: +49 6431 9577-0
E-mail: sales@moba.de

MOBA ITALY

37069 Villafranca die Verona / Italy
Phone: +39 045 630-0761
E-mail: salesitaly@moba.de

MOBA FRANCE

77164 Ferrières en Brie / France
Phone: +33 (0) 1 64 26 61 90
E-mail: infos@mobafrance.com

MOBA UK

HP178LJ Haddanham / UK
Phone: +44 184 429 3220
E-mail: ilewis@moba.de

MOBA SPAIN

08211 Barcelona / Spain
Phone: +34 93 715 87 93
E-mail: moba-ise@moba.de

MOBA USA

Peachtree City GA 30269 / USA
Phone: +1 678 8179646
E-mail: mobacorp@moba.de

MOBA BRASIL

Belo Horizonte - MG / Brasil
Phone: +55 31 7513-4959
E-mail: mobadobrasil@moba.de

NOVATRON FINLAND

33960 Pirkkala / Finland
Phone: +358 (0) 3 357 26 00
E-mail: sales@novatron.fi

MOBA SWEDEN

861 36 Timrå / Sweden
Phone: +46 (0) 73-3750097
E-mail: pwallgren@moba.de

MOBA TECMASERM

08700 Barcelona / Spain
Phone: +34 93 804 24 85
E-mail: moba-tecmaserm@moba.de

MOBA CHINA

116600 Dalian / China
Phone: +86 411 39269311
E-mail: ysun@moba.de

MOBA CHILE

Avda. Providencia 1476
Phone: +56 (9) 61678464
E-mail: mjmarco@moba.de

MOBA INDIA

Gujarat - 382044 / India
Phone: +91 989 855 6608
E-mail: sdesai@moba.de

MOBA DENMARK

5250 Odense / Denmark
Phone: +45 70 26 96 91
E-mail: jlindskov@moba.de

MOBA AUSTRALIA

Victoria 3061 / Australia
Phone: +61 393 570 055
E-mail: dramondetta@moba.de